

Standard Terminal Dimensions
(Optional terminal please check terminal information page)

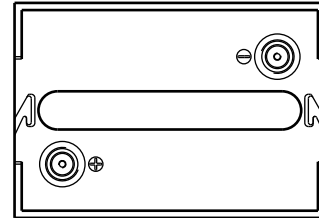
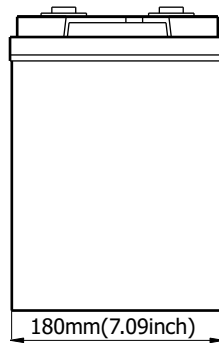
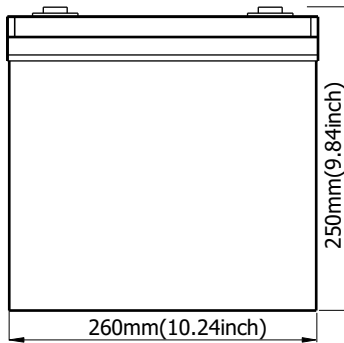

AGM and Gel

Range batteries uses the advanced GEL design which combines the best features of AGM and GEL construction into one battery line, and the purity fumed silica to form sulfuric acid thixotropic Gel and fills to the batteries with vacuum to ensure the fully penetration of electrolyte through separators and plates pastes.

This range battery are designed to meet the requirement of frequent cyclic and high temperature application such as boardband, PVs etc.

Application

- | | |
|-----------------------------|-----------------------|
| Broadband | Electric Powered Toys |
| Electric Powered Vehicles | Control System |
| UPS | Vacuum Cleaners |
| Photovoltaic & Solar system | Medical Equipments |
| | Golf Cars and Buggies |
| | Wheel Chairs |

General Features

- Ideal for cyclic uses
- Good tolerance to higher temperature applications.
- ABS containers and covers(UL94HB, UL94V-0) optional.
- Safety valve installation for explosion proof.
- Higher safety & reliable construction.
- Extra durability and deep cycle ability for heavy demand applications.
- Low self discharge characteristic.
- Good tolerance to higher temperature applications.

Construction

- | | | | |
|-----------|-------------------|--------------|------------------------------------|
| Component |Raw material | Sealant |Epoxy Resin |
| Positive |Lead dioxide | Safety valve |EPDR |
| Negative |Lead | Terminal |Copper |
| Container |ABS | Separator |AGM |
| Cover |ABS | Electrolyte |sulfuric acid thixotropic Gel |

Battery Model	GT6-200AG			
Designed Life	10 Years (Floating) or > 750 Cycles @ 50% D.O.D			
Capacity(25°C)	20HR(11.25A,1.75V)	10HR(19A,1.75V)	5HR(34A,1.75V)	1HR(120A,1.75V)
	200AH	190AH	170AH	1202AH
Dimensions	Length	Width	Height	Total Height
	260mm(10.2inch)	180mm(7.09inch)	245mm(9.65inch)	250mm(9.84inch)
Approx. Weight	31Kg (68.4 lbs)			
Internal Resistance	Full charged at 25°C: 0.0032 Ohm			
Self Discharge	3% of capacity declined per month at (25°C)			
Capacity Affected by Temp.(20HR)	40°C	25°C	0°C	-15°C
	102%	100%	85%	65%
Charge Voltage(25°C)	Cycle use		Float use	
	7.2-7.5V(-15mV/ °C), max. Current: 50A		6.8-6.9V(-10mV/ °C)	

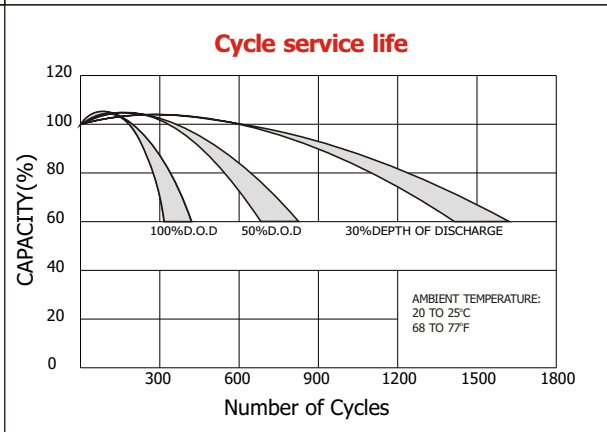
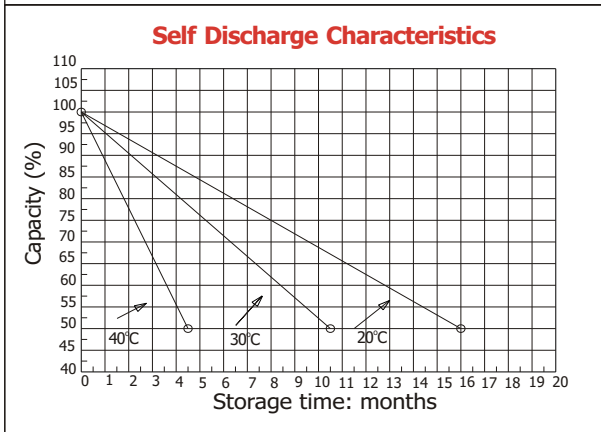
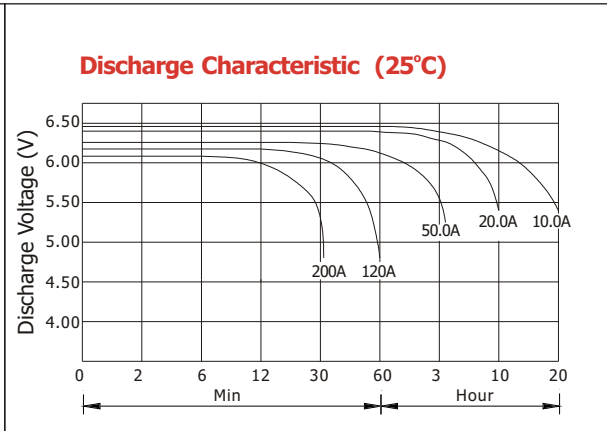
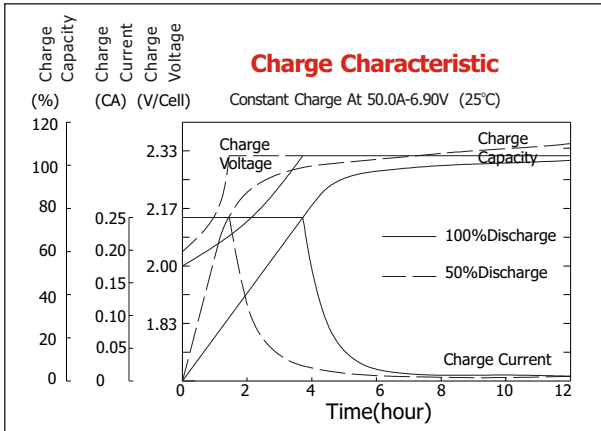

Constant current discharge ratings-amperes at 25°C

F. V/Time	5MIN	10MIN	15MIN	30MIN	1HR	3HR	5HR	10HR	20HR
1.60V	700	480	350	210	132	54.6	38.2	21.2	10.5
1.67V	630	438	340	204	132	54.4	37.8	20.9	10.5
1.70V	598	422	328	200	131	54.4	37.8	20.7	10.5
1.75V	532	390	310	196	130	54.0	37.5	20.4	10.5
1.80V	480	362	296	190	128	53.8	37.2	20.0	10.1
1.85V	364	298	256	175	127	53.6	36.9	19.7	9.48

Constant power discharge ratings-watts at 25°C

F. V/Time	5MIN	10MIN	15MIN	30MIN	1HR	3HR	5HR	10HR	20HR
1.60V	1154	796	620	396	260	105	73.0	42.4	21.1
1.67V	1094	786	614	388	251	105	73.0	41.8	21.0
1.70V	1022	766	604	378	245	105	73.0	41.5	21.0
1.75V	952	716	568	368	243	103	72.2	40.7	20.9
1.80V	854	666	534	358	238	102	71.0	40.0	20.2
1.85V	684	552	466	328	236	101	70.0	39.3	19.0

